

Laser Technology, Inc.

LTI 20/20
TruSpeed[®] S
User's Manual



© LTI 2015 TruSpeed S 0144851

 **LASER^{INC}
TECHNOLOGY**
Measurably Superior[®]

Copyright Notice:

Information in this document is subject to change without notice and does not represent a commitment on the part of Laser Technology Inc. No part of this manual may be reproduced in any form or by any means, electronic or mechanical, including photocopying, recording, or information storage and retrieval systems, for any purpose other than the purchaser's personal use, without the express written consent of Laser Technology, Inc.

Copyright (c)[2015] Laser Technology, Inc. All Rights Reserved.
Unauthorized duplication, in whole or in part, is strictly prohibited.

Printed in the United States of America

First Edition: July 2011

Second Edition: September 2011

Third Edition: March 2015

Trademarks:

TruSpeed is trademark of Laser Technology, Inc. All other trademarks are the property of their respective owner.

Patents:

This product is covered by pending patent applications and/or

one or more of the following issued patents: 5,359,404, 5,715,045, 5,521,696,
5,612,779, 6,445,444, 5,652,651

LTI Contact Information:

Laser Technology, Inc.
6912 S. Quentin Street
Centennial, CO 80112 USA

Phone: 1-303-649-1000
1-877-OWN-A-LTI (USA and Canada)

Fax: 1-303-649-9710

Web Site: www.lasertech.com

Email: service@lasertech.com

Table of Contents

Section #1 - Getting Started	3
Unpacking Your TruSpeed S	3
Important Safety Information	3
About the TruSpeed S	4
Sensors	5
Eyepiece	6
Focus Adjustment Ring	6
In-scope LCD	7
Test Port	7
Buttons	8
Installing / Removing the Battery	9
Battery Voltage Level	9
Attaching the Neckstrap	10
Powering ON the TruSpeed S	11
Powering OFF the TruSpeed S	11
Understanding the Display Indicators	12
Miscellaneous Display Features	14
Adjusting the Aiming Reticle's Intensity	15
Listening to the TruSpeed S	16
Understanding Error Conditions	17
Error Codes	17
RFI Considerations	18
Section #2 - Speed Measurements	19
Taking a Sample Measurement	20
Choosing a Roadside Location	21
Line of Sight	21
The Cosine Effect	21
Measuring a Moving Vehicle	23
Using the Weather Mode	25
Using the Continuous Mode	27

Section #3 - Test Mode	29
Display Integrity Test	29
Scope Alignment Test	30
Instrument Confidence Checks	31
Fixed Distance Test	32
Delta Distance Test	33
To Exit the Delta Distance Test	35
Self Test	35
To Exit the Self Test	36
Model and Firmware Version Number Display	36
Serial Number Display	37
Section #4 - Maintenance	38
Section #5 - Specifications	39
Section #6 - Troubleshooting Tips	40
Section #7 - Glossary	42
Index	43

Section #1 - Getting Started

Unpacking Your TruSpeed S

When you receive your TruSpeed S, check to make sure that you have received everything that you ordered, and that it all arrived undamaged.

TruSpeed S Basic Package

- TruSpeed S instrument with polarizing filter
- Carrying Case
- Neck Strap
- Connector Straps (quantity 2)
- Eyepiece Cover
- Lens Cloth
- CR123A battery (quantity 2)
- Quick Reference Field Guide
- User's manual

Important Safety Information

Avoid staring directly at the laser beam for prolonged periods.

- The TruSpeed S is designed to meet FDA eye safety requirements and is classified as eye-safe to Class 1 limits, which means that virtually no hazard is associated with directly viewing the laser output under normal conditions. As with any laser device, reasonable precautions should be taken in its operation. It is recommended that you avoid staring into the transmit lens while firing the laser. The use of optical instruments with this product may increase eye hazard.

Never attempt to view the sun through the scope.

- Looking at sun through the scope may permanently damage your eyes.

Never point the instrument directly at the sun.

- Exposing the lens system to direct sunlight, even for a brief period, may permanently damage the laser transmitter.

Avoid Direct Exposure on the Eyepiece

- Exposing the lens system to direct sunlight even for a brief period, may permanently damage the internal components.

Do not operate the instrument in extreme temperatures.

- TruSpeed S components are rated for a temperature range of -22 to 140° F. Do not operate the instrument in temperatures outside that range.

About the TruSpeed S

Laser Technology's LTI 20/20 TruSpeed S is part of the Laser Technology family of handheld laser speed and ranging devices. Compared to our other laser speed measurement products, the TruSpeed S includes:

- Simple 4 button operation for quick and easy access to speed measurements.
- Reduced size and weight.
- Ergonomic handheld design.
- Adjustable monocular to reduce eye fatigue.
- 7x magnification for superior targeting.
- In-scope LCD with aiming reticle for instantaneous access to speed measurements and options.
- Built-in Weather Mode that is an alternate speed measurement mode. It is a simplified gating option. This factory-defined gate ensures that targets are beyond the range where rain and snow can affect the laser's ability to capture a speed reading.
- Continuous Mode that is an alternate speed measurement mode. It displays one speed reading after another until you release the  button.
- Sounds and visual indicators that ensure confidence of positive target acquisition.
- Test port for verifying reference timing.

Figure #1 shows the TruSpeed S front, top, bottom and rear panels.

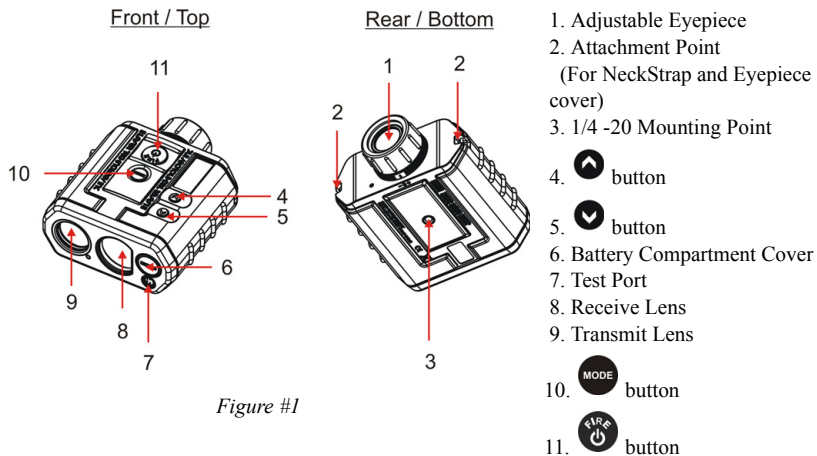

Figure #1

Sensors

The TruSpeed S has two lenses on the front panel. The left lens transmits the infrared laser signals. The right lens receives signals back from the target and feeds signal information to the internal circuitry.

The internal circuitry consists of a laser range sensor and timing, analysis, computation, and display circuits. The TruSpeed S determines distance through its laser range sensor, by measuring the time of flight of short pulses of infrared light. The TruSpeed S has a broad spectrum of sensitivity, and can work with both reflective and non-reflective targets. The maximum measurement distance varies with target and environmental conditions. The absolute maximum is approximately 2,000 feet.

Eyepiece

The eyepiece is located at the back of the TruSpeed S. It includes a 7X magnification scope that features an integrated polarizing light filter to optimize viewing contrast in any given environmental condition.



Eyepiece Cover:

The eyepiece cover protects the internal components from sunlight exposure. The eyepiece cover should be in place whenever the TruSpeed S is not in use.

To attach the eyepiece cover:

Feed the thin cord under the metal bar and flare the loop open. Pull the eyepiece cover through the loop and cinch tight.

Focus Adjustment Ring

The Focus Adjustment Ring allows you to focus the LCD in-scope display relative to the target for your eye. During assembly, optimum focus is set to infinity. To adjust the LCD focus, turn the Focus Adjustment Ring to suit your personal preference. See Figure #2.



Monocular adjustment reduces eye fatigue.

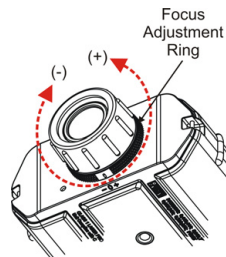

Figure #2

In-scope LCD

- The In-scope LCD displays menu items, option indicators, error codes, and speed measurement results.
- The aiming reticle helps you aim accurately to the target. Figure #3 shows the reticle which is located at the center of the in-scope LCD and represents the size of the laser beam.
- You can vary the intensity of the aiming reticle to account for different lighting conditions. For more information, see [page 15](#).

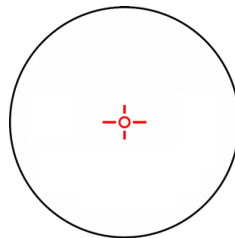

Figure #3

Test Port

Your TruSpeed S includes a Test Port located on the front panel. The Test Port allows the instrument to be connected to a remote computer for laboratory testing purposes only.

Buttons

The TruSpeed S has a 4-button keypad located on the top panel of the instrument. The buttons provide easy access to the instrument functions.

This manual refers to the buttons while the laser is oriented as shown in Figure #4. The table below lists the buttons and the functions of each.







Figure #4

	Initiate power ON Self Test.
	Initiate speed measurement.

	Toggle through menu options.
	Confirm/set selection.

	Change the LCD backlight level.
---	---------------------------------

	Toggle Continuous Mode and Weather Mode On/Off.
	Exit Test Mode and return to Speed Mode.

- Simultaneously pressing the  and  buttons turns the instrument off.
- While in a menu, simultaneously pressing the  and  buttons starts the measurement mode.

Installing / Removing the Battery

A CR 123A 3V Lithium battery is required to power the TruSpeed S. The battery is located in the Battery Compartment at the front of the instrument.

Installing the Battery

1. Remove the Battery Compartment Cover by lifting up the Hinged Tab and turning counter clockwise,
2. Insert the battery negative end (-) first.
3. Re-insert the Battery Compartment Cover and use the Hinged Tab to turn clockwise.
4. Press down on the Hinged Tab to secure.



To remove the battery, just reverse the above instructions.

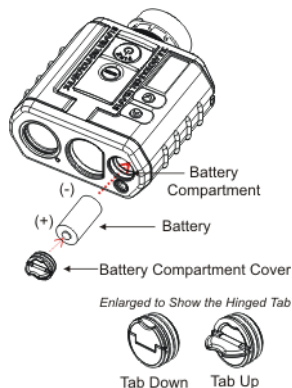

Figure #5

Battery Voltage Level

The TruSpeed S continuously monitors its power source. LTI has defined an acceptable battery voltage range to ensure that the instrument has sufficient battery voltage to guarantee correct operation.

Battery Icon Appearance	Explanation
Battery Icon Not Displayed	The estimated battery life is between 100% and 10%.
	The estimated battery life is between 10% and 5%.
	The estimated battery life is approximately 5% to 0%.

Attaching the Neckstrap

1. Find the two Attachment Points located on the rear panel of the TruSpeed S.
2. Insert the end of one of the connector straps into one side of the eyelet opening and feed it through to the other side.
3. Feed the strap up from the bottom of the buckle, then over the center of the buckle and back down through the other side.
4. Pull the strap to take up any slack and tighten the strap to simply have a loop that is fed through the eyelet.
5. Repeat steps 2-4 to attach the other connector strap to the other side of the TruSpeed S.
6. Attach one end of the neckstrap into the side release buckle of one of the connector straps.
7. Attach the other end of the neckstrap to the side release buckle of the other connector strap.

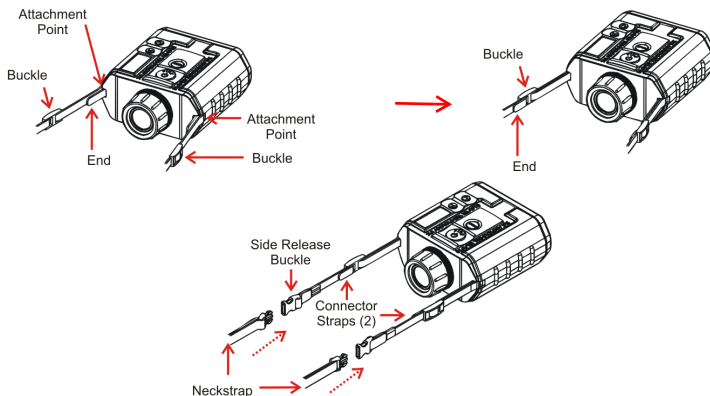



Figure #6



- Make sure the strap is straight when attaching it to the TruSpeed S. This will help you avoid uncomfortable twists in the strap that will rub your neck.
- Before use, check to make sure the neckstrap is secure. Failure to do so may result in the TruSpeed S hitting the ground or other object. If you drop the instrument, check the scope alignment ([page 30](#)) before using the instrument for speed measurement.
- The neckstrap may also be attached to the carrying case.

Powering ON the TruSpeed S

1. Press the  button. Briefly, the instrument will perform the Self Test.
 - *If all tests prove positive*, “PASS SELF” appears briefly in the in-scope LCD. Then the Speed Mode will be active and the Speed Measurement Screen will be displayed.
 - *If all tests do not prove positive*, the appropriate error code will appear in the in-scope LCD ([page 17](#)).

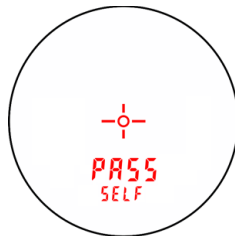





Figure #7

If the instrument fails the self test:



1. Press the  button and the  button simultaneously for one second to power off the instrument.
2. Press  button again to initiate another self test to see if it passes.
 - If the error persists, contact LTI Service. See the inside front cover for LTI contact information.

Powering OFF the TruSpeed S

1. Simultaneously press and hold the  and  buttons for one second.



To help save its battery:

- The TruSpeed S has a factory-defined power OFF interval. The instrument will automatically power OFF if there is no activity for a period of 30 seconds. Instrument activity includes any button presses.
- After a speed measurement is taken, if there is no button activity for 30 seconds, the unit will go into Hibernation Mode ([page 24](#)).

Understanding the Display Indicators

Figure #8 shows the LCD Screen when all indicators are active. The table below lists the display indicators and the function of each.

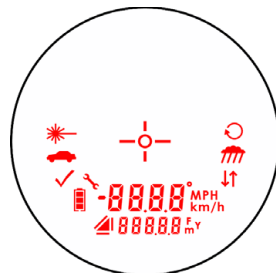



















Figure #8









Display Indicator	Function	Explanation
	Aiming	Serves as the aiming point reference, both horizontally and vertically.
	Laser Fire	The instrument's laser is firing.
	Speed Mode	The instrument's Speed Mode is active (page 19).
	Test Mode	The instrument's Test Mode is active (page 29).
	N/A	Reserved for future use.
	Battery	Identifies the approximate current battery voltage. The indicator shown here represents 10% - 5% battery life (page 9).

Display Indicator	Function	Explanation
	N/A	Reserved for future use.
	Upper Display	Provides access to speed measurements and messages.
	Lower Display	Provides access to range measurements and messages.
	N/A	Reserved for future use.
	Range Units	F: feet m: meters Y: yards
	Speed Units	km/h: Kilometers per Hour MPH: Miles per Hour
	N/A	Reserved for future use.
	Weather Mode	The instrument's Weather Mode is active (page 25).
	Continuous Mode	The instrument's Continuous Mode is active (page 27).

Miscellaneous Display Features





The upper and lower displays of the in-scope LCD are used to convey messages and measurement results.

- Upper Display (all segments active): 
- Lower Display (all segments active): 
- Numbers 0-9: 

Display Feature	Explanation	Refer to Pages
	Aiming reticle brightness. Where "--" is 01 to 05.	15
	Distance 1 of the Delta Distance Test.	33
	Distance 2 of the Delta Distance Test.	34
	Error message. Where "--" is the error code.	17
	During the Self Test, all tests proved positive.	11, 35
	Self Test.	11, 35
	Instrument serial number.	37
	Scope Alignment Test.	30

Adjusting the Aiming Reticle's Intensity

The in-scope aiming reticle has five intensity settings from DIM (1) to BRIGHT (5).

1. Looking through the eyepiece, press the  button. The display should look similar to Figure #9.
2. Press the  button until the desired setting is achieved. It's easy to get the desired setting if you look through the eyepiece while making the adjustment.
 - Each time you press the  button, the "brxx" value increases by 1.
 - If you press the  button while "br05" is displayed, you will see "br01" next.
3. Press the  button to return to the measurement mode that was most recently active.

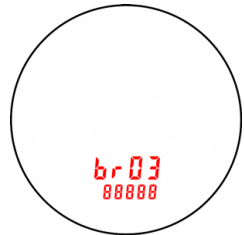



Figure #9

-  Powering OFF the instrument does not change this setting. The next time the instrument is powered ON, the setting will be the same.

Listening to the TruSpeed S

The TruSpeed S emits a variety of beeps and tones during use. The sounds vary and depend on what the instrument is doing. The table below lists and explains each of the sounds.

Sound	Explanation
3 Low Pitched and 1 High-Pitched Beeps	At power ON after successful completion of the Self Test.
Low-Pitched Growl	The instrument is attempting to lock onto a target.
1 Low Pitched and 2 High-Pitched Beeps	The instrument was not able to complete the intended speed measurement due to an error. An error code will be displayed to indicate the nature of the error (page 17).
High-Pitched Double Beep	The instrument successfully completed the intended speed measurement.

Understanding Error Conditions

Although it's rare, error conditions can occur during a measurement attempt or in the system hardware. To make sure that you never get an erroneous speed reading, the TruSpeed S monitors both the system hardware and the measurement. When the instrument detects an error condition, it displays an error code instead of a measurement. Figure #10 shows an example of an error code "E 01".

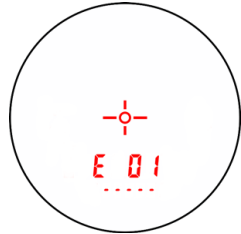

Figure #10

Error Codes

The table below lists and explains each of the possible error codes.

Code	Explanation
E 01	Measurement Error - the target was out of range or was too close.
E 03	Measurement Error - unstable targeting. Data is not stable enough to measure speed. <i>Possible Causes:</i> poor aiming or panning off the target.
E 03	Measurement Error - low level of interference from a light source such as a xenon headlight.
E 07	Jam Detect - high level of interference from a light source such as a xenon headlight.
E 52	Temperature too cold. Stop operation.
E 53	Temperature too hot. Stop operation.
E 54	Low battery.
E 55 E 57	Calibration Errors. Please turn OFF unit and try again.
E 56 E 58	If the same error is continuously repeated, please contact LTI Service.**
E 59	Receive circuit calibration failure. Please turn OFF unit and try again. If the same error is continuously repeated, please contact LTI. **
E 60	Memory failure. Please turn OFF unit and try again. If the same error is continuously repeated, please contact LTI Service. **

Code	Explanation
E 62	Receiver Failure. Please turn OFF unit and try again. If the same error is continuously repeated, please contact LTI Service. **
E 63 E 65 E 64 E 66 E 67	Code checksum failure. Please turn OFF unit and try again. If the same error is continuously repeated, please contact LTI. **
E 68	Power supply high voltage failure. Please turn OFF unit and try again. If the same error is continuously repeated, please contact LTI. **
E 71	System error. Please turn OFF unit and try again. If the same error is continuously repeated, please contact LTI. **
E 99	General System Failure. Please contact LTI Service. **

***See inside front cover for LTI contact information.*

RFI Considerations

The TruSpeed S does not display a specific error message indicating the presence of radio frequency interference (RFI). The instrument's electronics have been designed for optimum RFI immunity. If RFI is present, the instrument displays an error code. The exact code depends on the level and nature of the RFI.

Section #2 - Speed Measurements

When you power ON the TruSpeed S the instrument will perform the Self Test. Figure #11 shows successful completion of the Self Test. See [page 11](#) for more information about the Self Test that occurs when the instrument is powered ON.

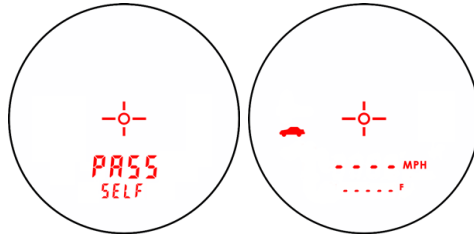



Figure #11

Figure #12

Using Figure #12 as an example:

- The dashes that appear in the upper display indicate where the speed measurement will appear.
- The  indicator means that the Speed Mode is active.
- "MPH" means the speed will be measured in miles per hour.
- The dashes that appear in the lower display indicate where the distance to the target vehicle will appear.
- "F" means the distance will be measured in feet.
- The Battery Icon indicates the approximate battery voltage level ([page 11](#)).

Taking a Sample Measurement





1. Ensure that the TruSpeed S is powered ON and that the Speed Mode is active. The  indicator should be displayed.
2. Looking through the eyepiece, use the reticle to aim the instrument to a convenient target - an interior wall will do. Please keep in mind that the TruSpeed S has a minimum range of 50 feet.
3. To fire the laser:



Figure #13

- Press and hold the  button. The laser will fire after a short delay (about one-half of a second).
 - The 1st press initiates the self test function then turns on the in-scope aiming reticle. Once the reticle is seen, the 2nd press takes the measurement.
4. Continue to press the  button and keep the instrument sighted on the Target to take consecutive measurements you will have to depress the  button for each measurement:

- A low-pitched growl means that the instrument is attempting to lock onto the target.
- 1 Low-Pitched and 2 High-Pitched Beeps mean that a measurement error occurred. An error code will be displayed ([page 17](#)).
- 2 high-pitched beeps mean that a speed was captured. The measured speed will be displayed on the in-scope LCD screen, just below the aiming reticle.

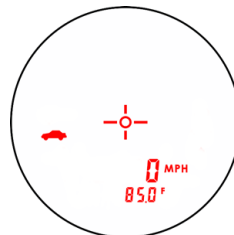



Figure #14

After you release the  button, the instrument will display the speed reading and the distance at which it was captured. The display screen should look similar to Figure #14. If you did not capture a speed, an error code will be displayed ([page 17](#)). You can take another speed measurement by repeating the steps above. If there is not button activity within 30 seconds, the unit will go into Hibernation Mode ([page 24](#)).

Choosing a Roadside Location

When choosing a spot on the side of the road for measuring moving vehicles, you will need to consider:

- Is the location safe?
- Do you have a clear line of sight?
- What is the approximate angle between the instrument's position and the target vehicle's direction of travel?
- What is the approximate distance to the target vehicles?
- How is the weather? Will you need to use the Weather Mode?

Line of Sight

Ideally, you should have a clear line of sight to the target vehicle.

- If there is a momentary break in the beam, if the instrument has accumulated enough data it may be able to capture the target vehicle's speed. The instrument will display an error code if it cannot capture the target vehicle's speed.
- If there is an extended break in the beam, the instrument will display an error code.

The Cosine Effect

If the target vehicle is moving directly toward or away from you, the speed measured by the TruSpeed S is identical to the vehicle's true speed. However, the instrument is usually set up on the side of the road for safety. This results in an angle between the instrument's position and the target vehicle's direction of travel. When the angle is significant, the measured speed is less than the target's true speed. The phenomenon is known as the cosine effect. Cosine is the trigonometric function that relates to this phenomenon.

The difference between the measured speed and the true speed depends upon the angle between the instrument's ideal position- the position where targets would be moving in direct line with the instrument- and its actual position.



- The larger the angle, the lower the measured speed.
- The effect always works to the motorist's advantage.
- Loosely speaking, the cosine effect is not significant as long as the angle remains small. The table below shows this effect.

Measured Speed by Angle: The Cosine Effect:

Angle (degrees)	True Speed				
	30 MPH	40 MPH	50 MPH	60 MPH	70 MPH
	Measured Speed (MPH)				
0	30.00	40.00	50.00	60.00	70.00
1	29.99	39.99	49.99	59.99	69.99
3	29.96	39.94	49.93	59.92	69.90
5	29.89	39.85	49.81	59.77	69.73
10	29.54	39.39	49.24	59.09	68.94
15	28.98	38.64	48.30	57.94	67.61
20	28.19	37.59	46.99	56.38	65.78
45	21.21	28.28	35.36	42.43	49.50
90	00.00	00.00	00.00	00.00	00.00

The cosine effect decreases as the range to the target vehicle increases.

- At the maximum range of the instrument, the vehicle is so far away that the angle between it and the instrument is very small indeed. The instrument's perception of the target's speed is identical to its true speed.
- As the vehicle approaches, the angle increases until it becomes large enough to affect the measurement.



To minimize the cosine effect, keep the angle small. Set up the instrument as close to the road as possible without creating safety risks, and target down the road at ranges sufficient to keep the angular difference small.

The table on the next page shows acceptable parameters for minimizing the cosine effect. The chart indicates the percentage of true speed measured, given the distance from the roadway and the distance from the target vehicle. To find a target's measured speed, multiply the true speed by the number in the chart.

Distance off the roadway (feet)	Range to Target Vehicle				
	100 ft	250 ft	500 ft	1000 ft	2000 ft
	<i>fraction of the true speed reported</i>				
10	.9950	.9992	.9998	.9999	1.0000
25	.9682	.9950	.9987	.9997	.9999
50	.8660	.9798	.9950	.9987	.9997
100		.9165	.9798	.9950	.9987
200		.6000	.9165	.9798	.9950

The crosshatch indicates impractical angles, i.e. distance off the road is greater than the range to the target.



- The diagonal created by the boldface numbers indicates the boundary between acceptable and unacceptable parameters.
- Numbers above the diagonal are acceptable margins of error.
- Numbers below the diagonal are unacceptable margins of error.

Remember that the cosine effect is always in the motorist's favor.



As a general rule, do not exceed 10 feet off the road for every 100 feet shooting down range to the targets. If target vehicles will be 500 feet down the road, set up no more than 50 feet off the road.

Measuring a Moving Vehicle

1. Ensure that the TruSpeed S is powered ON and that the Speed Mode is active as indicated by the  icon.
2. Look through the eyepiece and use the aiming reticle to aim the instrument at the target vehicle's license plate area and press the  button.

3. Continue to press the  button and keep the instrument sighted on the target
 - A low-pitched growl means that the instrument is attempting to lock onto the target.
 - 1 Low-Pitched and 2 High-Pitched Beeps mean that a measurement error occurred. An error code will be displayed.
 - 2 high-pitched beeps mean that a speed was captured. The measured speed will be displayed on the in-scope LCD screen, just below the aiming reticle.

While the instrument is attempting to lock onto the target, as long as the  button is kept pressed, it will retry the speed measurement.

- In this mode, the instrument will attempt to lock onto the target for up to 9.5 seconds. Information is accumulated until it gets a good measurement or generates an error code.
- Consequently, it is very important that the aiming point on the target remain constant for the entire measurement time. If you move the instrument off the aiming point, it will generate an error code instead of capturing a speed reading.

After you release the  button the instrument will display the most recent speed reading and the distance at which it was captured or an error code. When the most recent speed reading is displayed, the display screen will look similar to Figure #15.

- The speed displays as a negative number if the target was going away from you when it was measured.
- The speed displays as a positive number if the target was approaching you when it was measured.

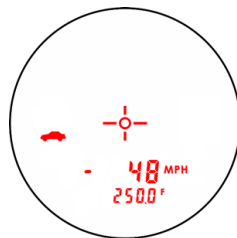



Figure #15



At this point, after the speed measurement is taken, if there is no button activity for 30 seconds, the unit will go into Hibernation Mode. The last speed

measurement will be held for up to 15 minutes. In this mode press the  button once to retrieve the speed measurement or twice to return to the active Speed Measurement Mode.



Using the Weather Mode

Moisture is reflective. Weather such as rain, snow, or fog can make it difficult for the laser to receive signals back from the target. This is especially true when you are trying to capture speeds at close range. The TruSpeed S includes a built-in Weather Mode that is an alternate speed measurement mode. When the Weather Mode is active, the factory-defined gate setting increases the instrument's minimum range from 50 feet to 200 feet. Increasing the minimum range ensures that the laser only acquires targets beyond the range where weather affects the laser's ability to capture a speed reading.

When the Weather Mode is active:

- The Weather Mode indicator  appears in the upper right corner of the in-scope display.
- Targets must be a distance greater than 200 feet.
- The instrument's maximum range is not changed.
- Other than the above items, the TruSpeed S operates the same as when the Speed Mode is active and the Weather Mode is not active.

To activate the Weather Mode:

1. Ensure that the TruSpeed S is powered ON and that the Speed Mode is active.
2. Press the  button until the Weather Mode indicator appears. The display should look similar to Figure #16.
3. Look through the eyepiece and use the reticle to aim the instrument at the target vehicle's license plate area and press the  button.
4. Continue to press the  button, and keep the instrument sighted on the target:
 - A low-pitched growl means that the instrument is attempting to lock onto the target.
 - 1 Low-Pitched and 2 High-Pitched Beeps mean that a measurement error occurred. An error code will be displayed.

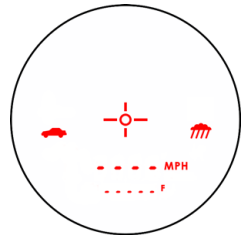





Figure #16

- 2 high-pitched beeps mean that a speed was captured. The measured speed will be displayed on the in-scope LCD screen, just below the aiming reticle.

While the instrument is attempting to lock onto the target, as long as the  button is kept pressed, it will retry the speed measurement.

- In this mode, the instrument will try up to 9.5 seconds. Information is accumulated until it gets a good measurement or generates an error code.
- Consequently, it is very important that the aiming point on the target remain constant for the entire measurement time. If you move the instrument off the aiming point, it will generate an error code instead of capturing a speed reading.

After you release the  button the instrument will display the most recent speed reading and the distance at which it was captured or an error code. When the most recent speed reading is displayed, the display screen will look similar to Figure #17.

 At this point, after the speed measurement is taken, if there is no button activity for 30 seconds, the unit will go into Hibernation Mode. The last speed measurement will be held for up to 15 minutes. In this

mode press the  button once to retrieve the speed measurement or twice to return to the active Speed Measurement Mode.

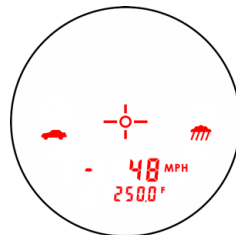





Figure #17



Using the Continuous Mode

Continuous Mode is an alternate speed measurement mode. If you wish to take several successive readings on a target, you can put the instrument in Continuous Mode. In this mode, the instrument takes and displays one reading after another, and continues to take and display readings as long as



you hold down the  button. When you release the  button, and the instrument finishes its

latest reading and stops. If an error code is shown when you release the  button, the instrument will display either the most recent speed reading, or, if the error code has persisted for several tries, the error code will remain.

When the Continuous Mode is active:

- The Continuous Mode indicator  appears in the upper right side of the in-scope display.
- When you wish to change targets, release the  button, aim to the new target, and refire.

To activate the Continuous Mode:

1. Ensure that the TruSpeed S is powered ON and that the Speed Mode is active.
2. Press the  button until the Continuous Mode indicator appears. The display should look similar to Figure #18.
3. Look through the eyepiece and use the reticle to aim the instrument at the target vehicle's license plate area and press the  button.
4. Continue to press the  button and keep the instrument sighted on the target:

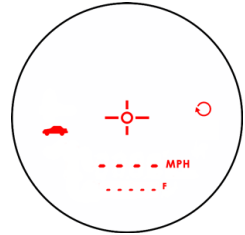

Figure #18

- A low-pitched growl means that the instrument is attempting to lock onto the target.
- A continuous beep means the laser is locked and tracking a target.

- 1 Low-Pitched and 2 High-Pitched Beeps mean that a measurement error occurred. An error code will be displayed.
- 2 high-pitched beeps mean that a speed was captured. The measured speed will be displayed on the in-scope LCD screen, just below the aiming reticle.

While the instrument is attempting to lock onto the target, as long as the



button is kept pressed, it will retry the speed measurement.

- In this mode, the instrument will try up to 9.5 seconds. Information is accumulated until it gets a good measurement or generates an error code.
- Consequently, it is very important that the aiming point on the target remain constant for the entire measurement time. If you move the instrument off the aiming point, it will generate an error code instead of capturing a speed reading.
- The instrument will take and display one reading after another as long as you hold

down the  button.

After you release the  button the instrument will display the most recent speed reading and the distance at which it was captured or an error code. When the most recent speed reading is displayed, the display screen will look similar to Figure #19.



At this point, after the speed measurement is taken, if there is no button activity for 30 seconds, the unit will go into Hibernation Mode. The last speed measurement will be held for up to 15 minutes.

In this mode, press the  button once to retrieve the speed measurement or twice to return to the active Speed Measurement Mode.

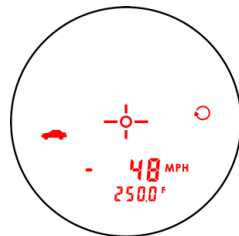

Figure #19

Section #3 - Test Mode

The Test Mode includes 6 options and allows you to verify the instrument's mechanics. These options include:

- Display Integrity Test
- Scope Alignment Test
- Delta Distance Test
 - Fixed Distance Test
- Self Test
- Model and Firmware Version Number Display
- Serial Number Display

Display Integrity Test

The Display Integrity Test allows you to verify that all display segments are operating. LTI suggests that you do this test periodically.

1. Ensure that the TruSpeed S is powered ON.
2. Press the  button. The display should look like Figure #20.
3. Compare the instrument's display to Figure #20. If any segment fails to display, contact LTI Service to arrange for repair. See the inside front cover for LTI contact information.

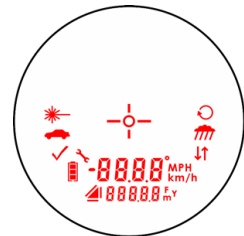





Figure #20



- Press the  button to display the Scope Alignment Test.
- Press the  button to adjust the Aiming Reticle intensity.
- Press the  button to return to the Speed Measurement Mode.
-  The display integrity is also tested each time the unit is powered ON. However, the results are only briefly displayed before the results of the Self Test are displayed.

Scope Alignment Test

Scope alignment is set at the factory when the instrument is shipped. A heavy blow is the only reason that the scope might ever go out of alignment. LTI suggests that you do this test periodically.

The Scope Alignment Test uses sound to indicate when the scope is on-target.

- Select a target. Choose a prominent target with well-defined horizontal and vertical edges. A telephone pole is an excellent choice.

 - The target's reflective qualities and distance should be such that you can clearly hear a change in pitch of the test tone as you pan the instrument over the edges of the target.
 - Make sure there is nothing behind the target that the instrument might detect, so you know without a doubt that any change in pitch is due strictly to the target.
- Ensure that the TruSpeed S is powered ON.
- Press the  button two times to activate the Test Tone display screen. It should look like Figure #21.
- Scan the target. Press and hold the  button while panning the instrument across the target. The tone changes pitch when the instrument acquires the target. The highest pitch - the on-target tone - should occur when the in-scope aiming reticle is centered on the target. Scan the target both horizontally and vertically.
 - If the frequency drops off at equal distances from the center of the aiming reticle, the instrument needs no adjustment. Otherwise, contact LTI Service for assistance with re-aligning the scope. See the inside front cover for LTI contact information.

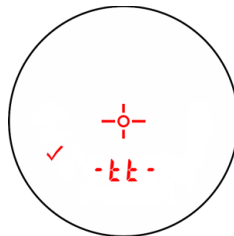





Figure #21

- Press the  button to display the Delta Distance Test.
- Press the  button to adjust the Aiming Reticle intensity.
- Press the  button to return to the Speed Measurement Mode.

Instrument Confidence Checks

There are several ways to verify the measurement accuracy of a lidar instrument. You can verify it directly by measuring the speed of an object traveling at a known speed, but this is seldom practical. The nature of Lidar is such that it cannot be tricked by a vibrating object, such as a tuning fork, into displaying a velocity. For these reasons, LTI has designed the Fixed Distance Test and the Delta Distance Test. LTI suggests that you do one of these tests each time the instrument is taken on duty.

These tests verify the accuracy of the two key elements of Lidar speed measurement:

- Precise time measurements
- Ability to make mathematical calculations

When setting up an area for these tests, LTI recommends:

- Permanently installing the test area in a convenient location. The test area must establish a permanent, known distance between a shooting mark and a target (Fixed Distance Test) or between a shooting mark and two targets (Delta Distance Test).
- Using metal tape to measure the distance; this will ensure that the measurement is accurate.

Other considerations:

- The shooting mark is where you stand to do the test, and can be an "X" painted on the pavement.
- A target can be any flat, permanent structure—a sign or wall, for example—painted with a bull's eye or other aiming point.
- The shooting mark and the target must form a straight line.
- The distance specified is horizontal distance. Horizontal distance is measured along a straight, level path from the shooting mark to the center of the aiming point.
- The manner in which you stand and hold the instrument both affect the test measurements. For exact readings, carefully hold the instrument so it is directly over the middle of the shooting mark.

Fixed Distance Test



The Fixed Distance Test is not one of the options included in the Test Mode. In order to perform the Fixed Distance Test, the Speed Mode must be active.

The Fixed Distance Test requires one target:

- LTI recommends using a target distance which is a whole foot for ease of use. However, if a distance of a whole foot is not available, a tenth of a foot will work. Please note, the distance to the target must be accurately measured with a certified measuring device, and the distance to the target must be greater than the minimum distance of the instrument, which is 50 feet. This example uses a distance of 175 feet.

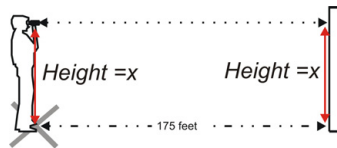

Note: For absolute accuracy, the instrument should be directly over the shooting mark and aimed parallel to the ground to the measured marks on the ground.

Hold the center of the TruSpeed S directly over the center of the shooting mark. If the surveyed distance is from the center of the shooting mark on the ground to the base of a wall, the operator should hold and aim the instrument parallel to the ground to achieve a straight and level path from the instrument to the target.

Figure #22

1. Stand over the shooting mark.
2. Ensure the TruSpeed S is powered ON and that the Speed Mode is active.
3. Look through the eyepiece and use the aiming reticle to aim to the target.
4. Press the  button.
5. Check the display. The speed reading should be 0 mph. A measurement of 0 mph verifies the timing accuracy of the instrument and is identical in nature to an accurate velocity reading of a vehicle moving at any speed. Speed accuracy: ± 1 mph.
 - The displayed distance should read from 174.5 to 175.5 feet if your fixed distance was 175 feet. Distance accuracy: ± 6 inches.



If you need assistance, contact Laser Technology, Inc. See the inside front cover for LTI contact information.

Delta Distance Test

The Delta Distance Test requires two targets. The distance to each target is not crucial. However, LTI recommends that the distance between the targets be to a whole foot for ease of use. The minimum distance to the first target must be greater than the minimum distance of the instrument which is 50 feet.

Refer to Figure #23 as a guide for positioning the targets and the shooting mark. This example uses 150 feet and 175 feet as the target distances.

1. Install the farthest target.
2. Measure 175 feet to the shooting mark and mark the shooting mark.
3. Measure from the shooting mark to the closer target at 150 feet.
4. Install the closer target at 150 feet.

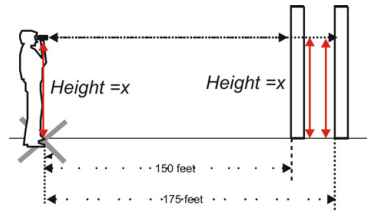





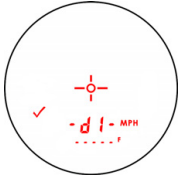

To conduct the test, refer to the table below.

Note: For absolute accuracy, the instrument should be directly over the shooting mark and aimed parallel to the measured marks on the ground.

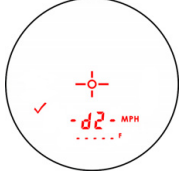
Figure #23

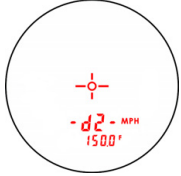
Action	Results
<ol style="list-style-type: none"> 1. Stand on the shooting mark. 2. Power ON the TruSpeed S and press the  button three times until the message -d1- appears in the upper display. 	



Action	Results
<p>3. Look through the eyepiece and aim to the far target and press the  button.</p> <p>4. Check the display. If necessary, you may repeat step #3.</p>	
<p>5. Press the  button. The message -d2- appears in the upper display.</p>	
<p>6. Look through the eyepiece and aim to the near target and press the  button.</p> <p>7. Check the display.If necessary, you may repeat step #6.</p>	
<p>8. Press the  button. The screen displays the simulated speed (50 MPH) ±1 MPH and the difference between the two distances (25.0 F) ±6 inches.</p>	
<p>If the targets are shot in reverse order, the display is the same, but the simulated speed appears as a negative number.</p>	

If the difference is 25.0 feet, the displayed simulated speed should be 49, 50, or 51 MPH, and the distance should be 24.5, 25.0, or 25.5 feet.



If you need assistance, contact Laser Technology, Inc. See the inside front cover for LTI contact information.



To Exit the Delta Distance Test

- Press the  button to display the Self Test.
- Press the  button to adjust the Aiming Reticle intensity.
- Press the  button to return to the Speed Measurement Mode.

Self Test

Just like when the instrument is powered ON, during the Self Test the microcontroller interrogates the system electronics.

To display the Self Test:

1. From speed measurement screen, press the  button four times. Figure #24 shows the initial display.
2. Press the  button.
 - *If all tests prove positive*, 3 Low Pitched and 1 High-Pitched beeps will sound. Figure #25 shows an example of all test proving positive.
 - *If all tests do not prove positive*, the appropriate error code will appear in the upper display ([page 17](#)).

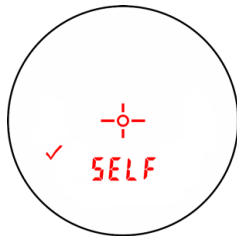

Figure #24

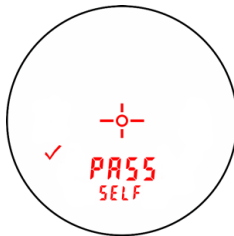





Figure #25





If the instrument fails the self test:

1. Press the  button and the  button simultaneously for one second to power off instrument.
2. Press  button again to initiate another self test to see if it passes.

If the error persists, contact LTI Service. See the inside front cover for LTI contact information.

To Exit the Self Test

- Press the  button to display the Model and Firmware Version Number.
- Press the  button to adjust the Aiming Reticle intensity.
- Press the  button to return to the Speed Measurement Mode.

Model and Firmware Version Number Display

To display the model number and firmware version number of your





TruSpeed S, press the  button five times. The model number appears in the upper display and the firmware version number appears in the lower display. The display should look similar to Figure #26. In this example, the model number is "100" and the firmware version number is "12.33".



Figure #26





Figure #26 uses firmware version 12.33 for the purpose of an example. Your TruSpeed S may include a different firmware version number.

- Press the  button to display the Instrument Serial Number.
- Press the  button to adjust the Aiming Reticle intensity.
- Press the  button to return to the Speed Measurement Mode.

Serial Number Display

To display the serial number of your TruSpeed S, press the  button six times. The serial number has 5 digits and appears in the upper and lower display. The display should look similar to Figure #27. In this example, the serial number is "00001".

- Press the  button to display the Display Integrity Test.
- Press the  button to adjust the Aiming Reticle intensity.
- Press the  button to return to the Speed Measurement Mode.

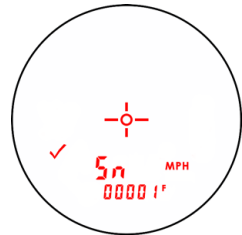

Figure #27

Section #4 - Maintenance

Operating Temperature

The instrument is rated for a temperature range of -22° F to +140° F. Do not operate the instrument in temperatures outside that range.

Moisture and Dust Protection

The TruSpeed S is sealed to provide protection from normally encountered field conditions. It is protected from dust and light moisture.

Shock Protection

The TruSpeed S is a precision instrument and should be handled with care. It will withstand a reasonable drop shock. If you drop the instrument, check the scope alignment ([page 30](#)) before using the instrument for speed measurement.

Cleaning and Storage

Clean the instrument after each use. Check for the following:

- Excess moisture. Towel off excess moisture and air dry the instrument at room temperature.
- Exterior dirt. Wipe exterior surfaces clean. Use isopropyl alcohol to remove dirt and fingerprints from the scope exterior.
- Dirty lenses. Use a lens brush to remove surface dust and loose particles from the front panel lenses. To clean a lens, moisten it with lens cleaning solution and wipe it with a clean cloth or lens tissue.
- Battery. If you won't be using the instrument again soon, remove the battery before storing it.

Caring for the Scope

Do not attempt to lubricate the scope. It is sealed from within using o-rings and special compounds. All seals are permanent and require no maintenance.

Use a lens brush to remove surface dust and loose particles. To clean a lens, moisten it with lens cleaning solution and wipe it with a clean cloth or lens tissue.

Checking the In-scope LCD



The instrument provides a method of verifying the display integrity. For more information, see [page 29](#).

Section #5 - Specifications

Weight:	0.9 lb with battery
Size:	5.2" L x 4.5" W x 2.1" H
Construction:	Glass filled polycarbonate composite
Maximum Range:	2,000 ft
Minimum Range:	
Speed Mode:	50 feet
Weather Mode:	200 feet
Continuous Mode:	50 feet
Range Accuracy:	± 6 inches
Display Resolution:	
Speed:	1 mph
Range:	0.1 unit of measure
Speed Range:	± 200 mph
Speed Accuracy:	± 1 mph
Measurement Type:	Continuous and single-shot
Power:	One CR 123A battery providing 12 hours of operation time
Measurement Time:	0.33 sec
Environment:	Water-resistant / NEMA 4 / IP 55
Temperature Range:	
Operating:	-22° to 140° F
Storage:	-31° to 158° F
Eye Safety:	Class 1; FDA CFR 21
Laser Wavelength:	905 nanometers (nominal)
Beam Divergence:	3.5 milliradians (nominal)

All specifications are subject to change without notice.

Section #6 - Troubleshooting Tips

What You Will See	Required Action
Unit powers OFF by itself. -or- No power at all.	<ul style="list-style-type: none"> • Verify that the battery is installed correctly. • Replace the battery. • Keep in mind that the instrument automatically powers OFF if there is no instrument activity for a period of 30 seconds.
The in-scope aiming reticle is not visible.	<ul style="list-style-type: none"> • Press the  to activate the aiming reticle. • Press the  button to increase the intensity of the aiming reticle.
E01 error code. No range or speed readings.	<ul style="list-style-type: none"> • Can you measure to a wall that is about 50 feet away? • Check the scope alignment. • When measuring a short range to a small target, aim slightly above the target.
Erroneous readings/not repeatable.	<ul style="list-style-type: none"> • Do you have a clear line of sight? • Check the scope alignment. • Is it raining or foggy. If yes, is the Weather Mode active? If not, turn it ON. Keep in mind that the minimum range will be 200 feet. • When measuring a short range to a small target, aim slightly above the target.
Limited Range.	<ul style="list-style-type: none"> • Do you have a clear line of sight? • Rain or fog will reduce the unit's maximum range. • Is the Weather Mode active? If not, turn it ON. Keep in mind that the minimum range will be 200 feet. • Keep in mind that acquiring a target through glass will reduce the unit's maximum range. • Make sure the lens is clean. • Check the lens for scratches.

What You Will See	Required Action
Difficult to acquire target while aiming through windshield.	<ul style="list-style-type: none">• Is the Weather Mode active? If not, turn it ON. Keep in mind that the minimum range will be 200 feet.• If the windshield is bubble-shaped, shoot through the center of the windshield.
Difficult to acquire target while aiming through rain or snow.	<ul style="list-style-type: none">• Is the Weather Mode active? If not, turn it ON. Keep in mind that the minimum range will be 200 feet.

Section #7 - Glossary

- beam divergence: The tendency of a laser beam to expand in diameter as it moves away from the source, measured in milliradians (mrad).
- Continuous Mode: Alternate speed measurement mode. Allows you to take several successive readings of a target vehicle. Re-fire for each new target. See [page 27](#).
- Delta Distance Test: Uses two measurements each to a known distance to verify the measurement accuracy of the TruSpeed S. See [page 33](#).
- Display Integrity Test: Allows you to verify that all segments of the in-scope LCD are operating. See [page 29](#).
- Fixed Distance Test: Uses one measurement to a known distance to verify the measurement accuracy of the TruSpeed S. See [page 32](#).
- laser: **Light Amplification by Stimulated Emission of Radiation.**
- lidar: A device that is similar in operation to radar, but emits pulsed laser light instead of radio waves.
- microcontroller: The computer processor that controls all of the functions of the TruSpeed S.
- Receive Lens: Located on the front panel of the TruSpeed S. It receives the signals back from the target and then feeds the signal information to the microcontroller. See [page 5](#).
- reticle: A scale located in the sighting scope that helps you aim to your target. It is visible when the TruSpeed S is powered ON. You may need to press the  button to see the reticle. See [page 7](#).
- Transmit Lens: Located on the front panel of the TruSpeed S. It transmits the infrared laser signals. See [page 5](#).
- Weather Mode: Alternate speed measurement mode. The laser only acquires targets that are beyond the range where weather affects the laser's ability to capture a speed reading. Targets must be at a distance greater than 200 feet. See [page 25](#).

Index

A

accuracy [39](#)
acquisition time [39](#)
aiming reticle [7](#)
 brightness [15](#)
 not visible [40](#)

B

battery
 conservation [11](#)
 installing [9](#)
battery voltage level [9](#)
beam divergence [39](#), [42](#)
beeps [16](#)
buttons [8](#)

C

cleaning [38](#)
Continuous Mode [27](#), [42](#)
cosine effect [21](#)
 how to minimize [22](#)
cover
 eyepiece [6](#)

D

Delta Distance Test [33](#), [42](#)
display indicators [12](#)
Display Integrity Test [29](#), [42](#)

E

error codes [17](#)
error conditions [17](#)
eye safety [3](#), [39](#)
eyepiece [6](#)

F

firmware
 version number [36](#)
Fixed Distance Test [32](#), [42](#)
Focus Adjustment Ring [6](#)

H

Hibernation Mode [11](#), [24](#), [26](#), [28](#)

I

in-scope LCD [7](#)

K

keypad [8](#)

L

laser [42](#)
laser wavelength [39](#)
LCD Screen [12](#)
lidar [42](#)
limited range [40](#)
line of sight [21](#)

M

microcontroller 42
 minimum range 39
 model number 36
 moisture protection 38
 monocular adjustment 6

N

neckstrap 10
 no power 40

O

operating temperature 3, 38

P

PASS 11, 35
 powering
 OFF 11
 ON 11

R

range resolution 39
 Receive Lens 42
 receive lens 5
 reticle 42
 RFI considerations 18
 roadside location
 how to choose 21

S

safety 3
 scope
 caring for 38
 Scope Alignment Test 30
 Self Test 35
 sensors 5
 serial number
 how to display 37
 shock protection 38
 size 39
 sounds 16
 specifications 39
 Speed Mode 19

T

temperature range 3, 38, 39
 Test Mode 29
 Test Port 7
 Transmit Lens 42
 transmit lens 5
 troubleshooting 40
 troubleshooting tips 40

U

Unit powers OFF 40

V

views
 of the TruSpeed S 5

W

Weather Mode 25, 42
 weight 39
 windshield
 aiming through 41

Notes:

